

ARCTEQ[®]

RELYABLE POWER

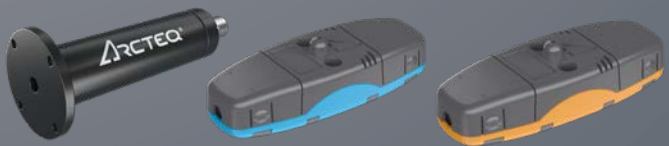

AQ 100 SERIES

ARC FLASH PROTECTION

CONTENTS

Full product range	3-5
Benefits of arc protection	6
Protection for personnel and equipment	7
Arcteq Innovation: Re-usable Quenching device according to IEC 60947 and UL 2748	8
Arcteq Innovation: Dedicated and dependable protection with standard arc schemes	9
Typical standard arc scheme for Low Voltage	10
Typical standard arc scheme for Medium Voltage	11
Arcteq Innovation: Adding pressure criteria in the arc flash protection	12
AQ-110P ARC Point sensor unit with overcurrent	13
AQ-110F ARC Fiber sensor unit with overcurrent	14
AQ-101 ARC Point sensor unit	15
AQ-101D ARC Point sensor unit	16
AQ-101S ARC Point sensor unit	17
AQ-102 ARC Fiber sensor unit	18
AQ-2000 ARC Quenching device	19
AQ-110PLV ARC Point sensor unit with overcurrent	20
AQ-110FLV ARC Fiber sensor unit with overcurrent	21
AQ-101LV ARC Point sensor unit	22
AQ-101DLV ARC Point sensor unit	23
AQ-102LV ARC Fiber sensor unit	24
AQ-1000 ARC Quenching device	25
Point sensors	26
Fiber optic sensors	27
Selection Table	28-29
Technical data	30-31
Typical wiring diagram	32
Installation and dimensions	33-35



S5 ***

THE MOST RELIABLE PROTECTION

The AQ 100 reliability is based on unbeatable experience in the field of arc protection. The unique standard arc schemes ensure correct operation under any condition.

When an arc burns there is no room for mistakes!



THE WIDEST RANGE OF PRODUCTS ON THE MARKET

The AQ 100 system enables arc flash protection systems over a wide range of applications. The full system can be anything from a single unit covering a few cubicles of switchgear to a complex multi incomer configuration with hundreds of units. Due to the unique design of the AQ 100 system, the number of units is nearly unlimited. The variety of sensors meet all philosophies of building up an arc flash system, it is possible to use point sensors, fiber sensors or a

mixture of the both. The AQ 100 system is always fast in operation, by adding an Arcteq reusable quenching device, you can get the total arcing time to less than 5 ms. In case of an arc flash fault in a system with an Arcteq quenching device, you remove the source of the arc fault and the power is back on in seconds or minutes. The quenching device can repeatedly take up to 100 kA arc faults reducing arc flash exposure typically to less than 1 calories.

MEDIUM VOLTAGE PRODUCTS



AQ-110P CURRENT AND LIGHT POINT SENSOR UNIT

Flush mounted current and light sensing main unit

4 current inputs, up to 12 light detectors and one light detecting fiber



AQ-110F CURRENT AND FIBER SENSOR UNIT

Flush mounted current and light sensing main unit

4 current inputs, up to 3 light detecting fibers



AQ-101 POINT SENSOR UNIT

Flush mounted light sensing unit installed as sub-unit to AQ-110P or standalone for light only system

Up to 12 light detectors and one light detecting fiber



AQ-101S POINT SENSOR UNIT (double BB /duplex)

Light sensing unit for double busbar applications. Installed as sub-unit to AQ-110P or standalone for light only system

Up to 12 light detectors



AQ-101D POINT SENSOR UNIT

Din rail mounted light sensing unit installed as sub-unit to AQ-110P or standalone for light only system

Up to 12 light detectors and one light detecting fiber



AQ-102 FIBER SENSOR UNIT

Flush mounted light sensing unit installed as sub-unit to AQ-110F or standalone for light only system

Up to 3 light detecting fibers



AQ-2000

Re-usable arc quenching device with rated voltage up to 17.5 kV

Arcteq's dedicated arc flash relays require minimal or no customer settings.

SENSORS (for MV and LV)



POINT SENSORS

For light and light & pressure



FIBER SENSORS

Plastic fiber or multithread glass fiber in variable lengths

LOW VOLTAGE PRODUCTS



AQ-110PLV CURRENT AND POINT SENSOR UNIT

Flush mounted current and light sensing main unit

3 current inputs, up to 12 light detectors and one light detecting fiber



AQ-110FLV CURRENT AND FIBER SENSOR UNIT

Flush mounted current and light sensing main unit

3 current inputs, up to 3 light detecting fibers



AQ-101LV POINT SENSOR UNIT

Flush mounted light sensing unit installed as sub-unit to AQ-110PLV or standalone for light only system

Up to 12 light detectors and one light detecting fiber



AQ-101DLV POINT SENSOR UNIT

Din rail mounted light sensing unit installed as sub-unit to AQ-110P or standalone for light only system

Up to 12 light detectors and one light detecting fiber



AQ-102LV FIBER SENSOR UNIT

Flush mounted light sensing unit installed as sub-unit to AQ-110FLV or standalone for light only system

Up to 3 light detecting fibers



AQ-1000

Re-usable Arc quenching device with rated voltage up to 690 V

BENEFITS OF ARC PROTECTION

The AQ 100 is designed utilizing the most modern technology with a focus on simplicity while maintaining both flexibility and function. It is built to meet the growing demands in both LV and MV switchgear and control gear applications ranging from basic standalone to more complex system solutions.

The AQ 100 series is designed and tested according to the latest protection relay standards and is hence suitable for installations in any environment, such as utility, power plant, wind-power, off-shore, marine, oil and gas, mining, steel or any other heavy industry application as well as commercial and institutional electrical systems. The AQ 100 modular design makes it an excellent candidate for both new and retrofit installations.

The Arteq arc quenching devices AQ-1000 and AQ-2000 are used to extinguish arcing faults in LV and MV power systems, typically where breaker operate times are not fast enough to reduce arc flash incident levels to a safe value.

The quenching device operates in less than 3 ms in order to minimize or even eliminate the arcing fault thermal and pressure damaging effects. In most applications this will result in a calorie/cm² energy release of less than 1. The AQ-1000 and AQ-2000 are fully reusable, they can do several operations with full short circuit current as well as allowing full system testing at site.

The arc quenching devices are installed as a part of the AQ 100 arc protection system. In case of an arc fault the AQ 100 detects the fault, triggers the quenching device and simultaneously trips the fault feeding circuit breaker(s). The quenching device creates a three-phase low impedance parallel path for fault current to flow thus extinguishing the arc fault instantaneously.



MAXIMUM SAFETY AND MINIMUM PROCESS DOWNTIME

- Total arc fault clearance time 5 ms with re-usable quenching device
- Quarter cycle arcing time guarantees low incident energy levels
- Lower category personal protective equipment (PPE) needed



SAVE TIME AND MONEY

- Faster engineering with standard arc schemes
- Faster commissioning, one button configuration, clear LED signals, no software needed
- Full product range → optimal price/functionality ratio for any application



THE MOST RELIABLE PROTECTION

- Design based on unbeatable experience in the field
- Track record of less than 0.1% return rate of products
- EMC isolation levels tested according to highest protection relay standards



SECURE OPERATION

- Designed and tested according to protection relay standards
- Re-usable arc quencher allows multiple operations in testing and fault conditions
- Optimized standard arc schemes for any type of switchgear
 - Individual trip zones based on light and current or light and pressure
 - Master trip to prevent back feed
 - Built in circuit breaker failure protection
 - Built in lock out



PROTECTION FOR PERSONNEL AND EQUIPMENT

The main purpose of an arc flash protection is to protect both substation personnel and equipment from the consequences of an arc fault. An arc protection system detects the fault in less than 2 ms and including the delay in the breaker the time for extinguishing the arc is normally less than 70 ms. A normal selective over current protection can have operation times up to 500 ms. In case of an arc fault in a switchgear equipped only with traditional feeder protection, the risk for severe injuries to substation personnel is very high.

The ultimate arc protection is the AQ 100 system including a quenching device AQ-1000 or AQ-2000. The ultrafast arc quenching device extinguishes the arc in less than 5 ms. In many cases this provides an alternate regarding more expensive arc resistant gear and a more effective solution to arc flash protection.

Use of quenching device reduces the calorie/cm² energy release typically to less than 1.

ARC QUENCHING

Typical protective equipment (PPE)



Level of damage



ARC QUENCHING	
Typical clearing time	5 ms
Typical worst-case incident energy level (IEEE 1584)	>1 cal/cm ²
Typical Personal Protective Equipment (PPE)	Category 1
Typical outage and repair time	Hour
Recommended	Fault current >10 kA and all important loads
Level of protection	ULTIMATE

ARC FLASH RELAY

Typical protective equipment (PPE)



Level of damage



ARC FLASH RELAY	
Typical clearing time	50-80 ms
Typical worst-case incident energy level (IEEE 1584)	<10 cal/cm ²
Typical Personal Protective Equipment (PPE)	Category 2
Typical outage and repair time	Hours
Recommended	Fault current <10 kA and non-important loads
Level of protection	GOOD

CONVENTIONAL RELAY

Typical protective equipment (PPE)



Level of damage



CONVENTIONAL RELAY	
Typical clearing time	>500 ms
Typical worst-case incident energy level (IEEE 1584)	>40 cal/cm ²
Typical Personal Protective Equipment (PPE)	Category 4
Typical outage and repair time	Days or weeks
Recommended	Never
Level of protection	BAD

ARCTEQ INNOVATION:

Re-usable arc quenching device according to IEC 60947 and UL 2748

ARC FLASH INCIDENTS

Arc flash faults are the most devastating types of faults known in power distribution systems. Arc flash incidents in medium and low voltage air insulated switchgear and control gear are known to cause annually a number of fatalities and personal injuries, mainly by 2nd degree and higher burns. Arc flash faults cause also severe equipment damage leading to time consuming repairs and extended power outages.

Arc flash has been greatly researched in the last decade and standards such as IEEE 1584 and NFPA 70E have been quantifying the arc flash incident energy to be directly proportional to system voltage, fault current and most critically the time that fault persists.

LIMITING THE ARCING TIME

Light and current based arc flash protection relays have been applied in medium and low voltage systems since 1980's. As fast as 2 millisecond trip time coupled with fast acting circuit breaker provides typically for 5-8 cycle total clearing time limiting the arc flash incident energy significantly compared to traditional overcurrent-based protection.

To overcome the limitation of the circuit breaker opening time Arcteq has developed arc quenching devices for low -and medium voltage systems. Arcteq arc quenching devices add to the well proven AQ 100 arc flash protection relay system. Arc quenching device operates on triggering signal from the arc flash relay and closes the three phases together creating a low impedance path for the fault current to flow. System voltages drops and fault is extinguished in 5 milliseconds from its initiation.

HARDENED, REUSABLE AND ULTRA-FAST

Arcteq arc quenching devices are fully reusable, and the system can be tested, and operation time verified at factory and site conditions. 5 ms total arcing time results typically in less than 1.2 calories/cm² incident energy levels. This ultra-fast protection reduces the system repair time from days and weeks to hours. Quenching devices are extremely heavy-duty, and they are rated for up to 100 kA fault currents to suite every application.

LOW AND MEDIUM VOLTAGE, RETROFIT AND NEW INSTALLATIONS

Arcteq has arc quenching solutions for both low- and medium voltage applications. The AQ-1000 is rated up to 690 V and 100 kA fault currents, whereas the AQ-2000 rates up to 17.5 kV and 50 kA currents.

The quenching device may be installed either in new or existing

panels. Retrofitting the quenching device in existing lineup is often an efficient way to prolong the switchgear lifetime. One device per busbar section is required and the device is mounted to most practical location depending on the switchgear construction. Typical locations are the voltage transformer compartments in medium voltage and incoming sections in low voltage applications. When installing arc quenching device, a particular attention must be paid to operating within the power system ratings.

NEW STANDARDS BY IEC AND UL

The first arc quenching device standards are released for low-voltage applications. Arcteq's AQ-1000 arc quenching device is tested and listed by the Underwriter's laboratory as per UL 2748 standard. The AQ-1000 also complies with newly released IEC 60947-9-1:2018 arc quenching device standard.

*Re-usable Quenching device
according to IEC 60947 and
UL 2748 standards.*



AQ-1000 arc quenching device

ARCTEQ INNOVATION:

Dedicated and dependable protection with standard arc schemes

ARC FLASH PROTECTION – THE NEW NORMAL IN POWER GRID PROTECTION

During the last decade the application of arc flash protection based on light sensing has become the new normal in power protection. Arc flash protection provides unquestionable benefits, such as improved speed, selectivity and cost effectiveness. Arc flash protection has been introduced to all continents and applied in all types of electrical power distribution systems ranging from electrical utility to traditional and renewable power generation, industrial, marine, off-shore, institutional and commercial applications in low and medium voltage switchgear and controlgear.

Protection relay manufacturers have incorporated arc flash protection features in numerical multifunction protection relays and IEDs. Because of this development, often arc flash protection is considered merely as an additional protection function. This approach has clear shortcomings in appreciating the criticality and complexity of the arc flash protection. Selective and tailored tripping scenarios must be designed in a way that protection operates flawlessly in all scenarios and in any network topology. At the same time, systems are to be designed with a total selectivity limiting the effected zone to minimum in case of an arc fault. Therefore, arc flash protection should not be considered as a protection function but as a protection system.

BENEFITS OF DEDICATED ARC FLASH PROTECTION RELAYS

Dedicated arc flash protection relays are designed to protect against arcing faults only. They operate in parallel with the numerical multifunction protection relays that provide the classical overcurrent-based protection schemes. This approach provides redundant protection and adds on protection dependability.

Arcteq's dedicated arc flash relays require minimal or no customer settings. This is of an essence as studies confirm that up to 85% of the maloperation of the protection is based on wrong settings.

Arcteq's arc flash relays are developed for system approach. Protection operation time is 7 ms for any number of circuit breakers under any operational scenarios. No inherent delays due to communication bus operating times is introduced. This is of the outmost importance when calculating the incident energy levels.

ARCTEQ'S UNIQUE STANDARD ARC SCHEMES – IMPROVED SECURITY THROUGH SIMPLICITY

Standard arc schemes have been introduced to provide pre-engineered and fully tested and documented arc flash protection systems for different switchgear layouts. The added flexibility in arc detection and protection systems has led to situations where manufacturers have not been able to test all possible combinations of the protection scheme designed. This has caused complexity in setting-up, wiring and commissioning of the systems. The use of standard arc schemes guarantees a fully tested and standard wiring and setting for the protection scheme.

Benefits of standard arc schemes are faster engineering, easier commissioning and dependable operation with minimal after sales and life cycle costs.



Standard arc schemes have been introduced to provide pre-engineered and fully tested and documented arc flash protection systems for different switchgear layouts.

TYPICAL STANDARD ARC SCHEME FOR LOW VOLTAGE

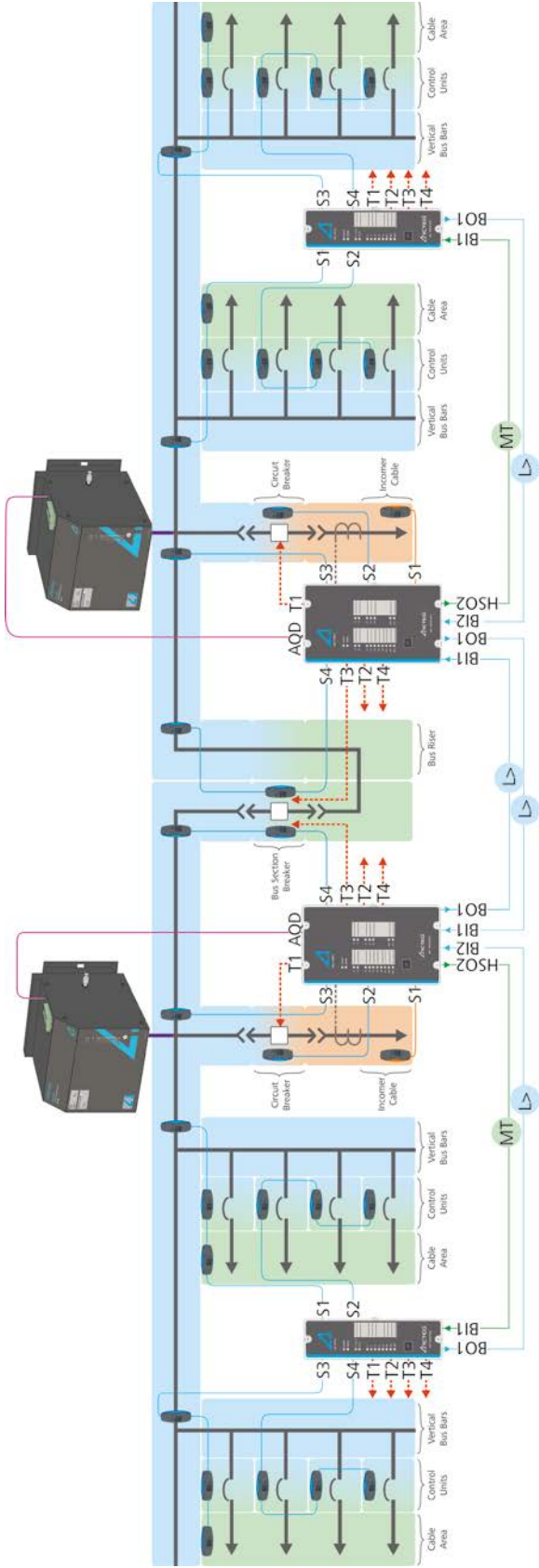

Standard arc scheme layout for low voltage switchgear with two incoming circuit breakers and a tie breaker.

TYPICAL STANDARD ARC SCHEME FOR MEDIUM VOLTAGE

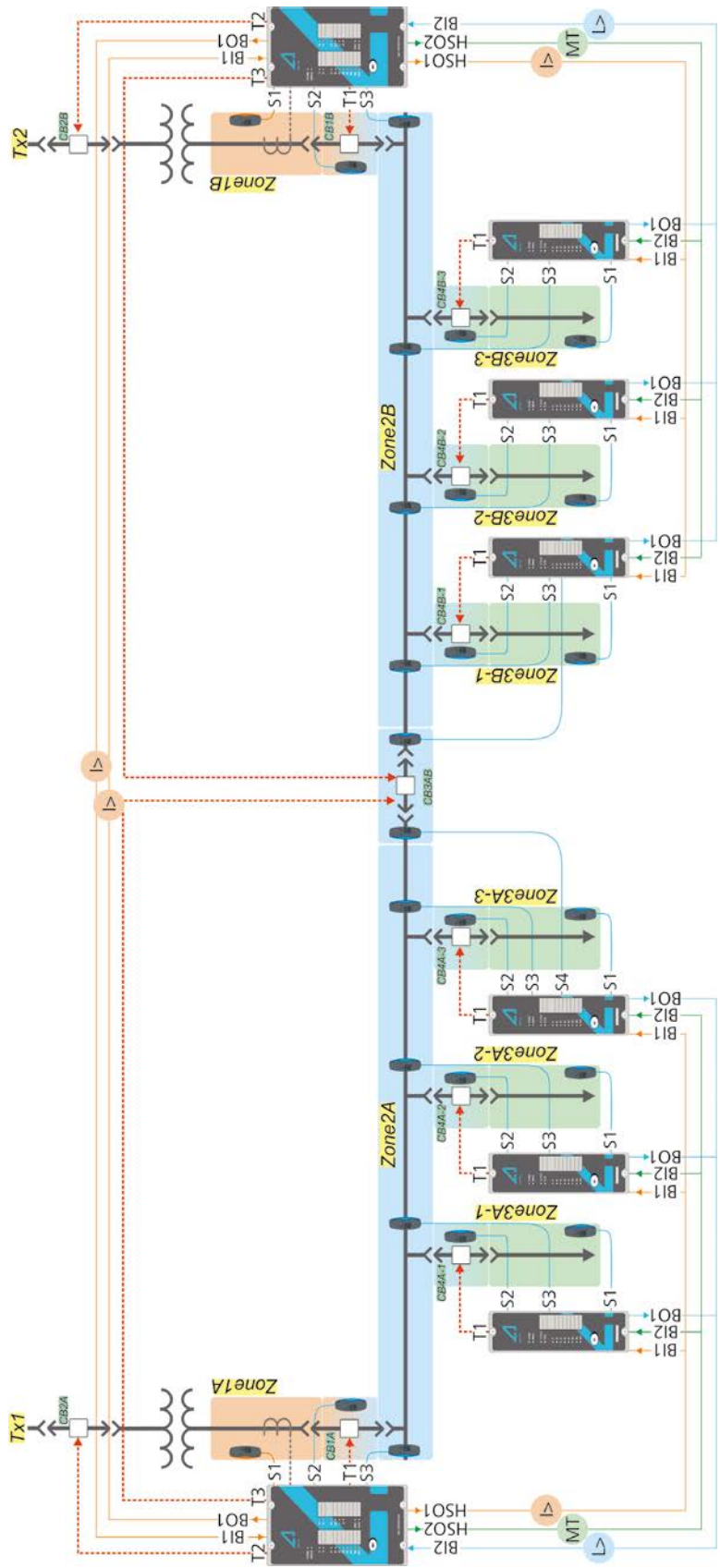

Standard arc scheme layout for medium voltage switchgear with two incoming circuit breakers and a tie breaker.

ARCTEQ INNOVATION:

Adding pressure criteria in the arc flash protection

BACKGROUND

The first generations of arc flash protection relays utilized light sensitive arc sensors alone as the tripping criteria. Advances combined arc light and current sensing for the dual sensing method to further increase the reliability of the protection system. However, the traditional current and light-based dual sensing system may overtrip when installed in equipment involving air magnetic circuit breakers. As well in some cases, especially in low voltage systems, the absence of current transformers makes it practically impossible to apply current criteria in the arc flash protection. Medium voltage switchgear's incoming cable compartments cannot be protected with light and current if the overcurrent is measured from the protected switchgear.

APPLYING LIGHT AND PRESSURE SENSOR WITH AIR CIRCUIT BREAKER

It is well known that low-voltage air circuit breakers create strong light emission during the breaking sequence under load. Further, when a low-voltage air circuit breaker or air magnetic circuit breaker operates on a downstream fault, its arc chutes create an arcing that may result in activating any arc light sensor installed nearby. Since downstream fault condition typically leads to exceeding of set overcurrent trip level, both light and current conditions may be fulfilled simultaneously and consequently the dual sensing arc flash protection system based on light and overcurrent may cause a nuisance trip of the incoming feeder circuit breaker.

Adding arc flash pressure sensor into the schemes involving air circuit breakers provides for additional trip criteria that will not be fulfilled in an event of normal circuit breaker operations and one can easily prevent potential nuisance trips. Using Arcteq's AQ-02 arc flash sensor combining arc light and pressure sensing in a single enclosure, a dual sensing system is achieved in a convenient and easy to install solution. If applying an overcurrent sensing into the system, even a triple sensing system based on current & light & pressure trip criteria can be utilized.

SENSOR AND SCHEME TESTING

Full arc flash protection scheme testing is the most important part of every project execution. Typical testing includes activation of each sensor and monitoring the correct feedback from all relays involved in the scheme. All primary equipment, including current transformers, circuit breakers and arc quenching devices, shall be tested as well to secure correct operation throughout the chain.

Arcteq's new arc light and pressure sensor testing device, AST-02 is designed to facilitate the system testing either in the factory or at site. Tester provides three different light threshold levels to secure correct operation of any light sensor independent of its sensitivity level. Pressure element can be triggered simultaneously to test the combined arc light and pressure sensor, AQ-02. The tester can be connected to any third-party relay tester to simulate the overcurrent condition and to record the total operation time of the arc flash protection system. Circuit breaker failure scheme can be also simulated with the AST-02 tester.

CONCLUSIONS

Applying light and pressure sensor addresses the shortcomings of light and current criteria. Applying pressure sensor in arc flash protection system provides for increased system reliability without compromising the desired dual sensing criteria. Adding the pressure criteria is especially encouraged in systems involving air magnetic circuit breakers. Pressure sensing should be considered also in case of absence of current transformers in protected zone. AQ-02 type of pressure and light sensor can be applied as a stand-alone solution with light and pressure tripping criteria alone, or in combination with overcurrent condition resulting in triple sensing criteria.

Pressure & light sensor can be used to eliminate nuisance trips with air circuit breakers.



AST-02 tester can be used for light and pressure testing



AQ-02 light & pressure sensor

AQ-110P ARC Point sensor unit with overcurrent

AQ-110P is a sophisticated microprocessor-based arc flash protection unit with combined current and arc sensing. When the AQ-110P detects an overcurrent in the incoming feeder and a light signal from a sub unit or a direct light sensor, it minimizes the damage caused by an arcing fault (arc flash) by tripping the circuit breaker sourcing the fault current. The AQ-110P complete system self-supervision function provides the highest level of dependability by continuously monitoring all internal system functions along with external connections.



ORDER CODE

AQ-110P - X X X X

- Auxiliary Power supply**
 - A 80...265 Vac/dc
 - B 18...72 Vdc
- Trip relay T3 characteristic**
 - A Normally open (NO) type
 - B Normally closed (NC) type
- Additional sensor channels**
 - A None
 - B Fiber optic sensor channel
- Binary inputs nominal voltage**
 - A 24 Vdc
 - B 110 Vdc
 - C 220 Vdc

- Arc current and light detection
- Connects to arc quenching device type AQ-1000 and AQ-2000 for rapid arc extinguishing
- Connects up to 12 point sensors
- Full self-supervision of all system components and interconnections

PROTECTION

- 50ARC Overcurrent
- 50NARC Ground fault
- Light L>
- Light and Pressure L>/P>
- Circuit Breaker Failure Protection 50BF
- Trip time using mechanical trip relays: 7 ms*
- Reset time (arc light stage): 2 ms
- Protection operational after power up: 88 ms
- *total trip time using arc light (L>) or phase/ground overcurrent (I>) from AQ-110 and arc light (L>)

I/O

Applicable sensors:

- AQ-01 a,b,c **light sensor
- AQ-02 light and pressure sensor
- AQ-06 plastic fiber sensor (5-50m length) (option)
- AQ-07 glass fiber sensor (5-60m length) (option)
- ** a = 8,000 Lux activation, b = 25,000 Lux activation, c = 50,000 Lux activation

Trip Relays T1, T2, T3, T4

- Number: 3 NO + 1 NC or 4 NO

- Rated voltage: 250 Vac/dc
- Continuous carry: 5 A
- Make and carry for 0.5s: 30 A
- Make and carry for 3s: 16 A
- Breaking capacity DC, when time constant L/R=40 ms: 40 W, 0.36 A at 110 Vdc
- Contact material: AgNi 90/10

Binary Output BO1

- Rated voltage: +24 Vdc
- Rated current: 20 mA (max)
- Number of outputs: 1

Binary Inputs BI1, BI2

- Threshold Voltage: 24 or 110 or 220 Vdc
- Rated Voltage: 250 V
- Rated current: 3 mA
- Number of inputs: 2

Power supply

- Us: 80...265 Vac/dc (option 18...72 Vdc)
- Maximum interruption: 100 ms
- Maximum power consumption: 5 W
- Standby current: 90 mA

HMI

- 12 Indication LED's

- Multifunction push button
- Autoconfiguration
- Indication reset
- System check

SELF SUPERVISION

- Sensors and wiring
- Binary I/O
- Trip coil
- Power supply
- Internal voltages
- Settings

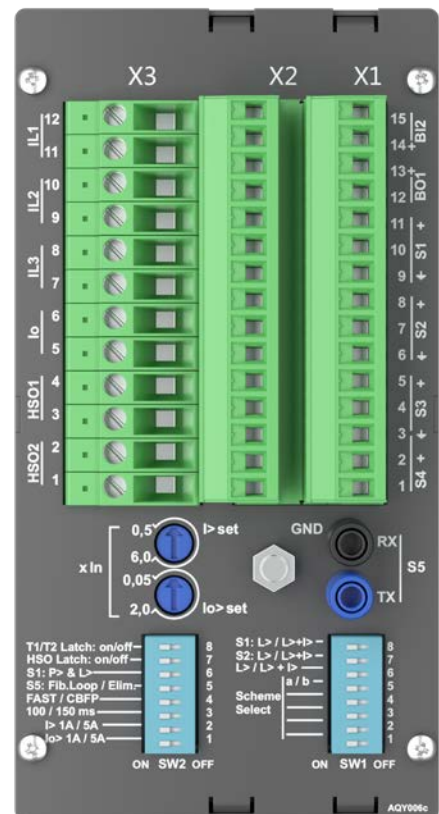

AQ-110P rear view

AQ-110F ARC Fiber sensor unit with overcurrent

AQ-110F is a sophisticated microprocessor-based arc flash protection unit with combined current and arc sensing. When the AQ-110F detects an overcurrent in the incoming feeder and a light signal from a sub unit or a direct light sensor, it minimizes the damage caused by an arcing fault (arc flash) by tripping the circuit breaker sourcing the fault current. The AQ-110 complete system self-supervision function provides the highest level of dependability by continuously monitoring all internal system functions along with external connections.

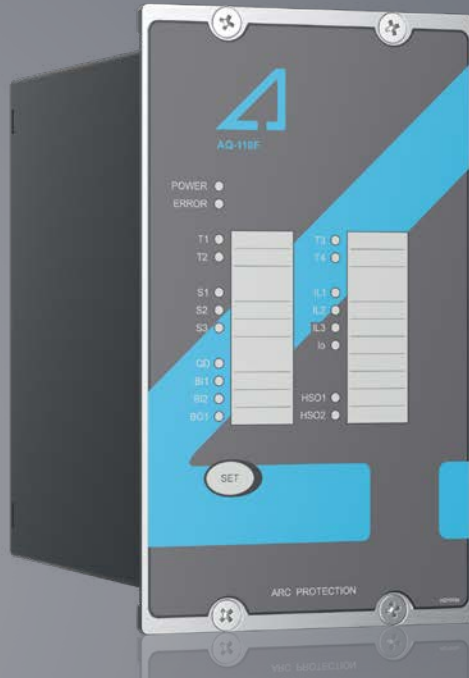

ORDER CODE

AQ-110F - X X X X

Auxiliary Power supply

- A 80...265 Vac/dc
- B 18...72 Vdc

Trip relay T3 characteristic

- A Normally open (NO) type
- B Normally closed (NC) type

Additional sensor channels

- A None
- B Fiber optic sensor channel

Binary inputs nominal voltage

- A 24 Vdc
- B 110 Vdc
- C 220 Vdc

- Connects 3 fiber sensors
- Superior isolation level for external disturbances – tested at the highest EMC classes
- As fast as 2 ms trip time
- Trips up to 4 breakers

PROTECTION

- 50ARC Overcurrent
- 50NARC Ground fault
- Light L>
- Light and Pressure L>/P>
- Circuit Breaker Failure Protection 50BF
- Trip time using mechanical trip relays: 7 ms*
- Reset time (arc light stage): 2 ms
- Protection operational after power up: 88 ms
- *total trip time using arc light (L>) or phase/ground overcurrent (I>) from AQ-110 and arc light (L>)

I/O

Applicable sensors: Max. 3
Sensors fibers

- AQ-06 plastic fiber sensor (5-50m length) (option)
- AQ-07 glass fiber sensor (5-60m length) (option)

Trip Relays T1, T2, T3, T4

- Number: 3 NO + 1 NC or 4 NO
- Rated voltage: 250 Vac/dc
- Continuous carry: 5 A
- Make and carry for 0.5s: 30 A

- Make and carry for 3s: 16 A
- Breaking capacity DC, when time constant L/R=40 ms: 40 W; 0.36 A at 110 Vdc
- Contact material: AgNi 90/10

Binary Output BO1

- Rated voltage: +24 Vdc
- Rated current: 20 mA (max)
- Number of outputs: 1

Binary Inputs BI1, BI2

- Threshold Voltage: 24 or 110 or 220 Vdc
- Rated Voltage: 250 V
- Rated current: 3 mA
- Number of inputs: 2

Power supply

- Us: 80...265 Vac/dc (option 18...72 Vdc)
- Maximum interruption: 100 ms
- Maximum power consumption: 5 W
- Standby current: 90 mA

HMI

- Indication LEDs: 20
- Multifunction push button
- Autoconfiguration

- Indication reset
- System check

SELF SUPERVISION

- Sensors and wiring
- Binary I/O
- Trip coil
- Power supply
- Internal voltages
- Settings
- CT connections

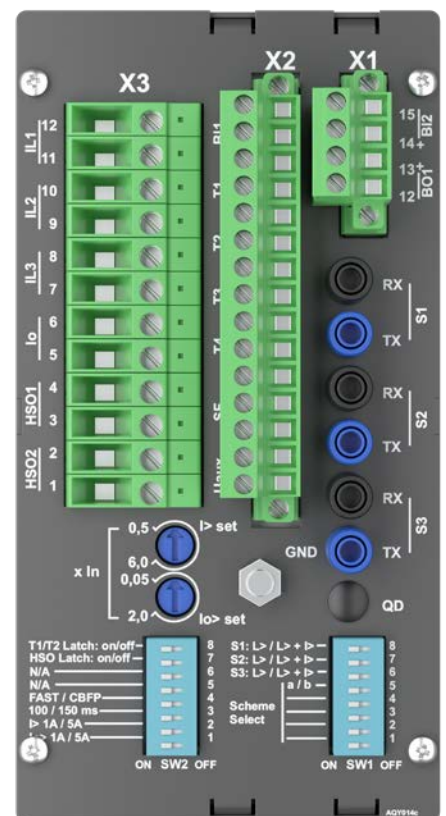

AQ-110F rear view

AQ-101 ARC Point sensor unit

AQ-101 is a sophisticated microprocessor-based arc flash protection unit for arc light detection. It is designed to minimize the damage caused by an arcing fault (arc flash) by tripping the circuit breaker sourcing the fault current. The AQ-101 acts as a sub unit to AQ-110P in an AQ 100 arc protection system. It can also function as standalone in light only systems. The AQ-101 complete system self-supervision function provides the highest level of dependability by continuously monitoring all internal system functions along with external connections.



ORDER CODE

AQ-101 - X X X X

Auxiliary Power supply

- A 80...265 Vac/dc
- B 18...72 Vdc

Trip relay T3 characteristic

- A Normally open (NO) type
- B Normally closed (NC) type

Additional sensor channels *)

- A None
- B Fiber optic sensor channel

Binary inputs nominal voltage

- A 24 Vdc
- B 110 Vdc
- C 220 Vdc

*) not applicable for AQ-101S

- Practically unlimited number of units can be interconnected in one system
- AQ 100 Standard Arc Scheme approach for fast engineering and simple setting
- Connects up to 12 point sensors and one optional fiber

PROTECTION

- Light L>
- Light and Pressure L>/P>
- Circuit Breaker Failure Protection 50BF
- Trip time using mechanical trip relays: 7 ms*
- Reset time (arc light stage): 2 ms
- Protection operational after power up: 88 ms
- *total trip time using arc light (L>) or phase/ground overcurrent (I>) from AQ-110 and arc light (L>)

I/O

Applicable sensors:

- AQ-01 a,b,c **light sensor
- AQ-02 light and pressure sensor
- AQ-06 plastic fiber sensor (5-50m length) (option)
- AQ-07 glass fiber sensor (5-60m length) (option)
- ** a = 8,000 Lux activation, b = 25,000 Lux activation, c = 50,000 Lux activation

Trip Relays T1, T2, T3, T4

- Number: 3 NO + 1 NC or 4 NO
- Rated voltage: 250 Vac/dc
- Continuous carry: 5 A

- Make and carry for 0.5s: 30 A
- Make and carry for 3s: 16 A
- Breaking capacity DC, when time constant L/R=40 ms: 40 W; 0.36 A at 110 Vdc
- Contact material: AgNi 90/10

Binary Output BO1

- Rated voltage: +24 Vdc
- Rated current: 20 mA (max)
- Number of outputs: 1

Binary Inputs BI1, BI2

- Threshold Voltage: 24 or 110 or 220 Vdc
- Rated Voltage: 250 V
- Rated current: 3 mA
- Number of inputs: 2

Power supply

- Us: 80...265 Vac/dc (option 18...72 Vdc)
- Maximum interruption: 100 ms
- Maximum power consumption: 5 W
- Standby current: 90 mA

HMI

- 12 Indication LED's
- Multifunction push button
- Autoconfiguration

- Indication reset
- System check

SELF SUPERVISION

- Sensors and wiring
- Binary I/O
- Trip coil
- Power supply
- Internal voltages
- Settings

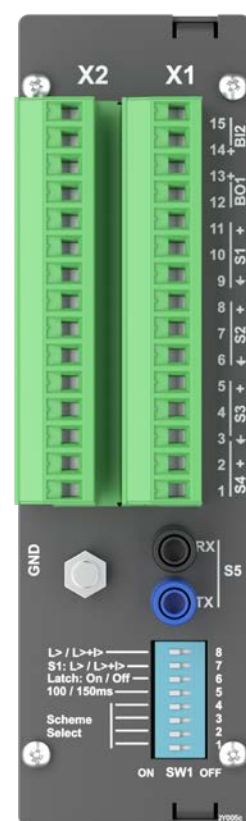

AQ-101 rear view

AQ-101D ARC Point sensor unit

AQ-101D is a sophisticated microprocessor-based arc flash protection unit for arc light detection. It is designed to minimize the damage caused by an arcing fault (arc flash) by tripping the circuit breaker sourcing the fault current. The AQ-101D acts as a sub unit to AQ-110P in an AQ 100 arc protection system. It can also function as standalone in light only systems. The AQ-101D complete system self-supervision function provides the highest level of dependability by continuously monitoring all internal system functions along with external connections.

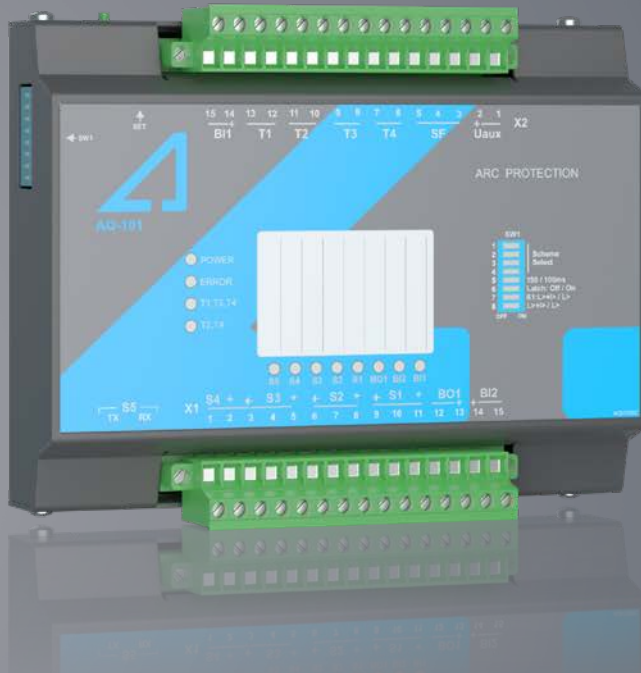

ORDER CODE

AQ-101D - X X X X

Auxiliary Power supply

- A 80...265 Vac/dc
- B 18...72 Vdc

Trip relay T3 characteristic

- A Normally open (NO) type
- B Normally closed (NC) type

Additional sensor channels *)

- A None
- B Fiber optic sensor channel

Binary inputs nominal voltage

- A 24 Vdc
- B 110 Vdc
- C 220 Vdc

*) not applicable for AQ-101S

- Easy din rail installation
- 12 indication leds for fault analyses

PROTECTION

- Light L>
- Light and Pressure L>/P>
- Circuit Breaker Failure Protection 50BF
- Trip time using mechanical trip relays: 7 ms*
- Reset time (arc light stage): 2 ms
- Protection operational after power up: 88 ms
- *total trip time using arc light (L>) or phase/ground overcurrent (I>) from AQ-110 and arc light (L>)

I/O

Applicable sensors:

- AQ-01 a,b,c **light sensor
- AQ-02 light and pressure sensor
- AQ-06 plastic fiber sensor (5-50m length) (option)
- AQ-07 glass fiber sensor (5-60m length) (option)
- ** a = 8,000 Lux activation, b = 25,000 Lux activation, c = 50,000 Lux activation

Trip Relays T1, T2, T3, T4

- Number: 3 NO + 1 NC or 4 NO
- Rated voltage: 250 Vac/dc
- Continuous carry: 5 A
- Make and carry for 0.5s: 30 A
- Make and carry for 3s: 16 A
- Breaking capacity DC, when time constant L/R=40 ms: 40 W; 0.36 A at 110 Vdc
- Contact material: AgNi 90/10

Binary Output BO1

- Rated voltage: +24 Vdc
- Rated current: 20 mA (max)
- Number of outputs: 1

Binary Inputs BI1, BI2

- Threshold Voltage: 24 or 110 or 220 Vdc
- Rated Voltage: 250 V
- Rated current: 3 mA
- Number of inputs: 2

Power supply

- Us: 80...265 Vac/dc (option 18...72 Vdc)
- Maximum interruption: 100 ms
- Maximum power consumption: 5 W

- Standby current: 90 mA

HMI

- 12 Indication LED's
- Multifunction push button
- Autoconfiguration
- Indication reset
- System check

SELF SUPERVISION

- Sensors and wiring
- Binary I/O
- Trip coil
- Power supply
- Internal voltages
- Settings

The AQ-101D complete system self-supervision function provides the highest level of dependability by continuously monitoring all internal system functions along with external connections.

AQ-101S ARC Point sensor unit

AQ-101S is a sophisticated microprocessor-based arc flash protection unit for arc light detection. It is designed to minimize the damage caused by an arcing fault (arc flash) by tripping the circuit breaker sourcing the fault current. The AQ-101S acts as a sub unit to AQ-110P in an AQ 100 arc protection system. It can also function as standalone in light only systems. It is designed to minimize the damage caused by an arcing fault (arc flash) by tripping the circuit breaker sourcing the fault current.

The AQ-101S has extended I/O count for status information from bay disconnect switch for the special arc scheme for double busbar installation. The AQ-101S complete system self-supervision function provides the highest level of dependability by continuously monitoring all internal system functions along with external connections.



ORDER CODE

AQ-101S - X A A X

Auxiliary Power supply

- A 80...265 Vac/dc
- B 18...72 Vdc

Binary inputs nominal voltage

- A 24 Vdc
- B 110 Vdc
- C 220 Vdc

- Extended I/O for double busbar installation
- Standard hard-wiring practice for communication between units
- Superior isolation level for external disturbances – tested at the highest EMC classes

PROTECTION

- Light L>
- Light and Pressure L>/P>
- Circuit Breaker Failure Protection 50BF
- Trip time using mechanical trip relays: 7 ms*
- Reset time (arc light stage): 2 ms
- Protection operational after power up: 88 ms
- *total trip time using arc light (L>) or phase/ground overcurrent (I>) from AQ-110 and arc light (L>)

I/O

Applicable sensors: Max. 12 sensors

- AQ-01 a,b,c **light sensor
- AQ-02 light and pressure sensor
- ** a = 8,000 Lux activation, b = 25,000 Lux activation, c = 50,000 Lux activation

Trip Relays T1, T2, T3

- Number: 2 NO + 1 NC or 3 NO
- Rated voltage: 250 Vac/dc
- Continuous carry: 5 A

- Make and carry for 0.5s: 30 A
- Make and carry for 3s: 16 A
- Breaking capacity DC, when time constant L/R=40 ms: 40 W; 0.36 A at 110 Vdc
- Contact material: AgNi 90/10

Binary Output BO: 3

- Rated voltage: +24 Vdc
- Rated current: 20 mA (max)
- Number of outputs: 1

Binary Input: 6

- Threshold Voltage: 24 or 110 or 220 Vdc
- Rated Voltage: 250 V
- Rated current: 3 mA
- Number of inputs: 2

Power supply

- Us: 80...265 Vac/dc (option 18...72 Vdc)
- Maximum interruption: 100 ms
- Maximum power consumption: 5 W
- Standby current: 90 mA

HMI

- Indication LED's: 17
- Multifunction push button
- Autoconfiguration
- Indication reset
- System check

SELF SUPERVISION

- Sensors and wiring
- Binary I/O
- Trip coil
- Power supply
- Internal voltages
- Settings

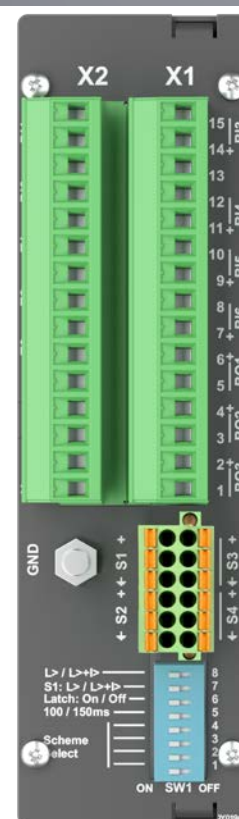

AQ-101S rear view

AQ-102 ARC Fiber sensor unit

AQ-102 is a sophisticated microprocessor-based arc flash protection unit for arc light detection. The AQ-102 have connectors for up to 3 fiber sensors. The AQ-102 acts as a sub unit to AQ-110 in an AQ 100 arc protection system. It can also function as standalone in light only systems. It is designed to minimize the damage caused by an arcing fault (arc flash) by tripping the circuit breaker sourcing the fault current. The AQ-102 complete system self-supervision function provides the highest level of dependability by continuously monitoring all internal system functions along with external connections.



ORDER CODE

AQ-102 - X X X X

Auxiliary Power supply

- A 80...265 Vac/dc
- B 18...72 Vdc

Trip relay T3 characteristic

- A Normally open (NO) type
- B Normally closed (NC) type

Quenching Device connector

- A None
- B Quenching Device

Binary inputs nominal voltage

- A 24 Vdc
- B 110 Vdc
- C 220 Vdc

- Connects up to 3 fiber sensors
- Full self-supervision of all system components and interconnections
- Easy adaptation to any switchgear and trip scheme

PROTECTION

- Light L>
- Light and Pressure L>/P>
- Circuit Breaker Failure Protection 50BF
- Trip time using mechanical trip relays: 7 ms*
- Reset time (arc light stage): 2 ms
- Protection operational after power up: 88 ms
- *total trip time using arc light (L>) or phase/ground overcurrent (I>) from AQ-110 and arc light (L>)

I/O

Applicable sensors: Max. 3 sensor loops

- AQ-06 plastic fiber sensor (5-50m length)
- AQ-07 glass fiber sensor (5-60m length)

Trip Relays T1, T2, T3, T4

- Number: 3 NO + 1 NC or 4 NO
- Rated voltage: 250 Vac/dc
- Continuous carry: 5 A
- Make and carry for 0.5s: 30 A
- Make and carry for 3s: 16 A

- Breaking capacity DC, when time constant L/R=40 ms: 40 W; 0.36 A at 110 Vdc
- Contact material: AgNi 90/10

Binary Output BO1

- Rated voltage: +24 Vdc
- Rated current: 20 mA (max)
- Number of outputs: 1

Binary Inputs B11, B12

- Threshold Voltage: 24 or 110 or 220 Vdc
- Rated Voltage: 250 V
- Rated current: 3 mA
- Number of inputs: 2

Power supply

- Us: 80...265 Vac/dc (option 18...72 Vdc)
- Maximum interruption: 100 ms
- Maximum power consumption: 5 W
- Standby current: 90 mA

HMI

- Indication LED's: 12
- Multifunction push button
- Autoconfiguration

- Indication reset
- System check

SELF SUPERVISION

- Sensors and wiring
- Binary I/O
- Trip coil
- Power supply
- Internal voltages
- Settings

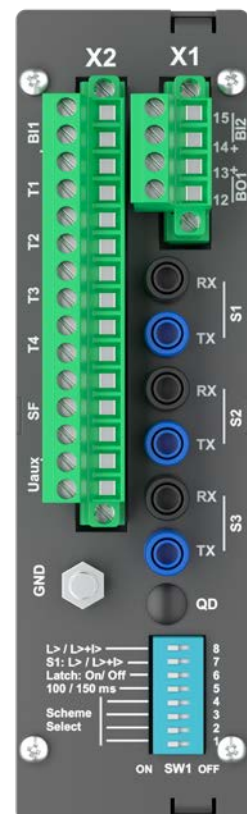

AQ-102 rear view

AQ-2000 ARC Quenching device

The AQ-2000 is an arc flash quenching device which extinguishes arcing faults within 5 ms of arc initiation. AQ-2000 is installed as a part of the AQ 100 arc protection system. In case of an arc fault the AQ 100 detects the fault, triggers the AQ-2000 arc quenching device and simultaneously trips the fault feeding circuit breaker(s). The AQ-2000 creates low impedance parallel path for fault current to flow. The total time for extinguishing the arc is less than 6 ms, this mitigates risk for personal injuries and damage to equipment.



ORDER CODE

AQ-2000

- Mitigates risk of injury during operations and maintenance
- Minimizes damage to equipment
- Applicable for new or retrofit installation

AQ-2000T – CAPACITIVE TRIGGER DEVICE

- Power supply: 24 Vdc
- Rated voltage: 400 Vdc
- Trigger current pulse: 4000 A

AQ-2000Q – QUENCHING DEVICE

- Rated voltage: up to 17.5 kV
- Short-circuit withstand: 40 kA for 1 second
- BIL: 38/95 kV
- Peak current: 100 kA
- Electric life: 2 operations at 40 kA, 100 ms each
- Mechanical life: 12 operations
- Total system operation time <6 ms

*Re-usable arc
quenching device for
less than 6 ms total
arcing time.*



AQ-2000 arc quenching device

AQ-110PLV ARC Point sensor unit with overcurrent

AQ-110PLV is a sophisticated microprocessor-based arc flash protection unit with combined current and arc sensing. When the AQ-110PLV detects an overcurrent in the incoming feeder and a light signal from a sub unit or a direct light sensor, it minimizes the damage caused by an arcing fault (arc flash) by tripping the circuit breaker sourcing the fault current. The AQ-110PLV complete system self-supervision function provides the highest level of dependability by continuously monitoring all internal system functions along with external connections.



ORDER CODE

AQ-110PLV - X X X X

Auxiliary Power supply

- A 80...265 Vac/dc
- B 18...72 Vdc

Trip relay T3 characteristic

- A Normally open (NO) type
- B Normally closed (NC) type

Additional sensor channels

- A None
- B Fiber optic sensor channel

Binary inputs nominal voltage

- A 24 Vdc

- Arc current and light detection
- Connects to arc quenching system type AQ-1000 and AQ-2000 for rapid arc extinguishing
- Connects up to 12 point sensors
- Full self-supervision of all system components and interconnections

PROTECTION

- Light L>
- Light and Pressure L>/P>
- Circuit Breaker Failure Protection 50BF
- Trip time using mechanical trip relays: 7 ms*
- Reset time (arc light stage): 2 ms
- Protection operational after power up: 88 ms
- *total trip time using arc light (L>) or phase/ground overcurrent (I>) from AQ-110 and arc light (L>)

I/O

Applicable sensors

- AQ-01 a,b,c **light sensor
- AQ-02 light and pressure sensor
- AQ-06 plastic fiber sensor (5-50m length) (option)
- AQ-07 glass fiber sensor (5-60m length) (option)
- ** a = 8,000 Lux activation, b = 25,000 Lux activation, c = 50,000 Lux activation

Trip Relays T1, T2, T3, T4

- Number: 3 NO + 1 NC or 4 NO
- Rated voltage: 250 Vac/dc
- Continuous carry: 5 A
- Make and carry for 0.5s: 30 A

- Make and carry for 3s: 16 A
- Breaking capacity DC, when time constant L/R=40 ms: 40 W; 0.36 A at 110 Vdc
- Contact material: AgNi 90/10

Binary Output BO1

- Rated voltage: +24 Vdc
- Rated current: 20 mA (max)
- Number of outputs: 1

Binary Inputs BI1, BI2

- Threshold Voltage: 24 Vdc
- Rated Voltage: 250 V
- Rated current: 3 mA
- Number of inputs: 2

Power supply

- Us: 80...265 Vac/dc (option 18...72 Vdc)
- Maximum interruption: 100 ms
- Maximum power consumption: 5 W
- Standby current: 90 mA

HMI

- 12 Indication LED's
- Multifunction push button
- Autoconfiguration
- Indication reset
- System check

SELF SUPERVISION

- Sensors and wiring
- Binary I/O
- Trip coil
- Power supply
- Internal voltages
- Settings

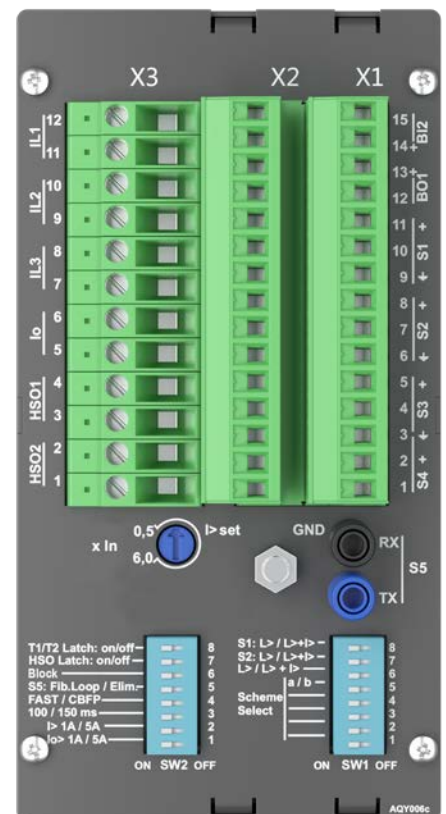

AQ-110PLV rear view

AQ-110FLV ARC Fiber sensor unit with overcurrent

AQ-110FLV is a sophisticated microprocessor-based arc flash protection unit with combined current and arc sensing. It is designed to minimize the damage caused by an arcing fault (arc flash) by tripping the circuit breaker sourcing the fault current. The AQ-110FLV complete system self-supervision function provides the highest level of dependability by continuously monitoring all internal system functions along with external connections.



ORDER CODE

AQ-110FLV - X X X X

Auxiliary Power supply

- A 80...265 Vac/dc
- B 18...72 Vdc

Trip relay T3 characteristic

- A Normally open (NO) type
- B Normally closed (NC) type

Additional sensor channels

- A None
- B Fiber optic sensor channel

Binary inputs nominal voltage

- A 24 Vdc

- Connects 3 fiber sensors
- Superior isolation level for external disturbances – tested at the highest EMC classes
- As fast as 2 ms trip time
- Trips up to 4 breakers

PROTECTION

- 50ARC Overcurrent
- 50NARC Ground fault
- Light L>
- Light and Pressure L>/P>
- Circuit Breaker Failure Protection 50BF
- Trip time using mechanical trip relays: 7 ms*
- Reset time (arc light stage): 2 ms
- Protection operational after power up: 88 ms
- *total trip time using arc light (L>) or phase/ground overcurrent (I>) from AQ-110 and arc light (L>)

I/O

Applicable sensors: Max. 3

Sensors fibers

- AQ-06 plastic fiber sensor (5-50m length) (option)
- AQ-07 glass fiber sensor (5-60m length) (option)

Trip Relays T1, T2, T3, T4

- Number: 3 NO + 1 NC or 4 NO
- Rated voltage: 250 Vac/dc
- Continuous carry: 5 A
- Make and carry for 0.5s: 30 A
- Make and carry for 3s: 16 A

- Breaking capacity DC, when time constant L/R=40 ms: 40 W; 0.36 A at 110 Vdc
- Contact material: AgNi 90/10

Binary Output BO1

- Rated voltage: +24 Vdc
- Rated current: 20 mA (max)
- Number of outputs: 1

Binary Inputs BI1, BI2

- Threshold Voltage: 24 Vdc
- Rated Voltage: 250 V
- Rated current: 3 mA
- Number of inputs: 2

Power supply

- Us: 80...265 Vac/dc (option 18...72 Vdc)
- Maximum interruption: 100 ms
- Maximum power consumption: 5 W
- Standby current: 90 mA

HMI

- Indication LEDs: 20
- Multifunction push button
- Autoconfiguration
- Indication reset
- System check

SELF SUPERVISION

- Sensors and wiring
- Binary I/O
- Trip coil
- Power supply
- Internal voltages
- Settings
- CT connections

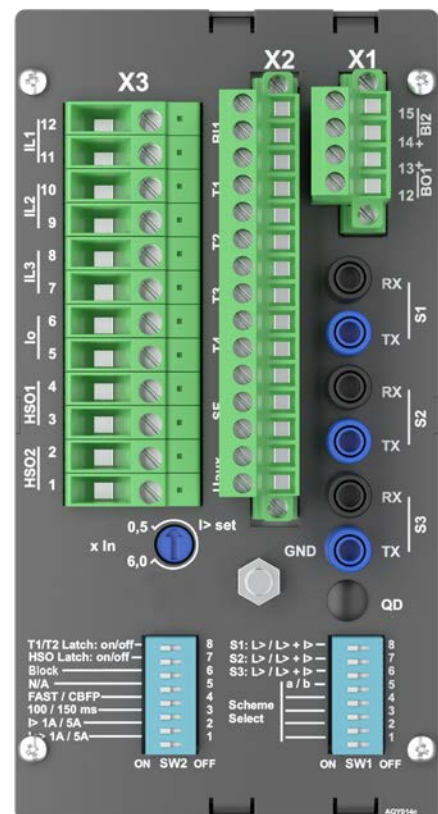

AQ-110FLV rear view

AQ-101LV ARC Point sensor unit

AQ-101LV is a sophisticated microprocessor-based arc flash protection unit for arc light detection. The AQ-101LV acts as a sub unit to AQ-110P in an AQ 100 arc protection system. It can also function as standalone in light only systems. It is designed to minimize the damage caused by an arcing fault (arc flash) by tripping the circuit breaker sourcing the fault current. The AQ-101LV complete system self-supervision function provides the highest level of dependability by continuously monitoring all internal system functions along with external connections.



ORDER CODE

AQ-101LV - X X X X

Auxiliary Power supply

- A 80...265 Vac/dc
- B 18...72 Vdc

Trip relay T3 characteristic

- A Normally open (NO) type
- B Normally closed (NC) type

Additional sensor channels

- A None
- B Fiber optic sensor channel

Binary inputs nominal voltage

- A 24 Vdc

- Practically unlimited number of units can be interconnected in one system
- AQ 100 Standard Arc Scheme approach for fast engineering and simple setting
- Connects up to 12 point sensors and one optional fiber

PROTECTION

- Light L>
- Light and Pressure L>/P>
- Circuit Breaker Failure Protection 50BF
- Trip time using mechanical trip relays: 7 ms*
- Reset time (arc light stage): 2 ms
- Protection operational after power up: 88 ms
- *total trip time using arc light (L>) or phase/ground overcurrent (I>) from AQ-110 and arc light (L>)

I/O

Applicable sensors:

- AQ-01 a,b,c **light sensor
- AQ-02 light and pressure sensor
- AQ-06 plastic fiber sensor (5-50m length) (option)
- AQ-07 glass fiber sensor (5-60m length) (option)
- ** a = 8,000 Lux activation, b = 25,000 Lux activation, c = 50,000 Lux activation

Trip Relays T1, T2, T3, T4

- Number: 3 NO + 1 NC or 4 NO
- Rated voltage: 250 Vac/dc
- Continuous carry: 5 A
- Make and carry for 0.5s: 30 A

- Make and carry for 3s: 16 A
- Breaking capacity DC, when time constant L/R=40 ms: 40 W; 0.36 A at 110 Vdc
- Contact material: AgNi 90/10

Binary Output BO1

- Rated voltage: +24 Vdc
- Rated current: 20 mA (max)
- Number of outputs: 1

Binary Inputs BI1, BI2

- Threshold Voltage: 24 Vdc
- Rated Voltage: 250 V
- Rated current: 3 mA
- Number of inputs: 2

Power supply

- Us: 80...265 Vac/dc (option 18...72 Vdc)
- Maximum interruption: 100 ms
- Maximum power consumption: 5 W
- Standby current: 90 mA

HMI

- Indication LED's: 12
- Multifunction push button
- Autoconfiguration
- Indication reset
- System check

SELF SUPERVISION

- Sensors and wiring
- Binary I/O
- Trip coil
- Power supply
- Internal voltages
- Settings

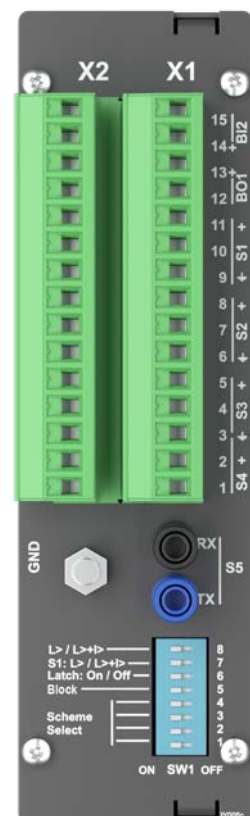

AQ-101LV rear view

AQ-101DLV ARC Point sensor unit

AQ-101DLV is a sophisticated microprocessor-based arc flash protection unit for arc light detection. It is designed to minimize the damage caused by an arcing fault (arc flash) by tripping the circuit breaker sourcing the fault current. The AQ-101DLV acts as a sub unit to AQ-110P in an AQ 100 arc protection system. It can also function as standalone in light only systems. The AQ-101DLV complete system self-supervision function provides the highest level of dependability by continuously monitoring all internal system functions along with external connections.

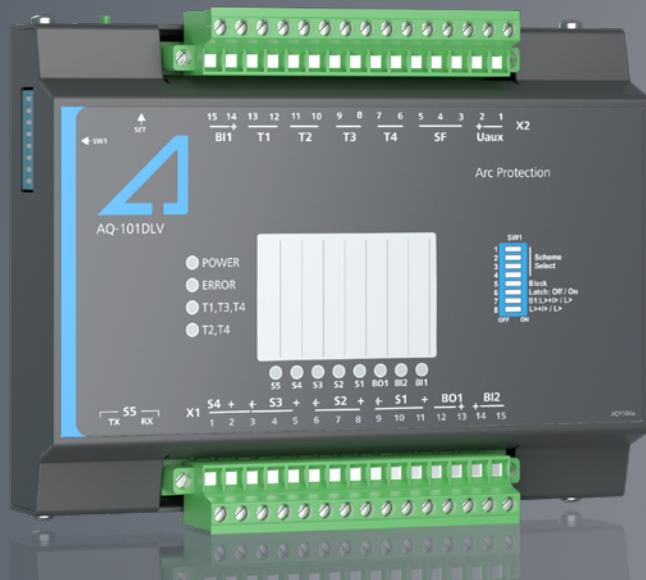

ORDER CODE

AQ-101DLV - X X X X

Auxiliary Power supply

- A 80...265 Vac/dc
- B 18...72 Vdc

Trip relay T3 characteristic

- A Normally open (NO) type
- B Normally closed (NC) type

Additional sensor channels

- A None
- B Fiber optic sensor channel

Binary inputs nominal voltage

- A 24 Vdc

- Easy din rail installation
- 12 indication leds for fault analyses

PROTECTION

- Light L>
- Light and Pressure L>/P>
- Circuit Breaker Failure Protection 50BF
- Trip time using mechanical trip relays: 7 ms*
- Reset time (arc light stage): 2 ms
- Protection operational after power up: 88 ms
- *total trip time using arc light (L>) or phase/ground overcurrent (I>) from AQ-110 and arc light (L>)

I/O

Applicable sensors:

- AQ-01 a,b,c **light sensor
- AQ-02 light and pressure sensor
- AQ-06 plastic fiber sensor (5-50m length) (option)
- AQ-07 glass fiber sensor (5-60m length) (option)
- ** a = 8,000 Lux activation, b = 25,000 Lux activation, c = 50,000 Lux activation

Trip Relays T1, T2, T3, T4

- Number: 3 NO + 1 NC or 4 NO
- Rated voltage: 250 Vac/dc
- Continuous carry: 5 A
- Make and carry for 0.5s: 30 A

- Make and carry for 3s: 16 A
- Breaking capacity DC, when time constant L/R=40 ms: 40 W; 0.36 A at 110 Vdc
- Contact material: AgNi 90/10

Binary Output BO1

- Rated voltage: +24 Vdc
- Rated current: 20 mA (max)
- Number of outputs: 1

Binary Inputs BI1, BI2

- Threshold Voltage: 24 Vdc
- Rated Voltage: 250 V
- Rated current: 3 mA
- Number of inputs: 2

Power supply

- Us: 80...265 Vac/dc (option 18...72 Vdc)
- Maximum interruption: 100 ms
- Maximum power consumption: 5 W
- Standby current: 90 mA

HMI

- 12 Indication LED's
- Multifunction push button
- Autoconfiguration
- Indication reset
- System check

SELF SUPERVISION

- Sensors and wiring
- Binary I/O
- Trip coil
- Power supply
- Internal voltages
- Settings

The AQ-101D complete system self-supervision function provides the highest level of dependability by continuously monitoring all internal system functions along with external connections.

AQ-102LV ARC Fiber sensor unit

AQ-102LV is a sophisticated microprocessor-based arc flash protection unit for arc light detection. The AQ-102LV have connectors for up to 3 fiber sensors. The AQ-102LV acts as a sub unit to AQ-110 in an AQ 100 arc protection system. It can also function as standalone in light only systems.

It is designed to minimize the damage caused by an arcing fault (arc flash) by tripping the circuit breaker sourcing the fault current. The AQ-102LV complete system self-supervision function provides the highest level of dependability by continuously monitoring all internal system functions along with external connections.



ORDER CODE

AQ-102LV - X X X X

Auxiliary Power supply

- A 80...265 Vac/dc
- B 18...72 Vdc

Trip relay T3 characteristic

- A Normally open (NO) type
- B Normally closed (NC) type

Quenching Device connector

- A None
- B Quenching Device

Binary inputs nominal voltage

- A 24 Vdc

- Connects up to 3 fiber sensors with maximum length 50 m each
- Full self-supervision of all system components and interconnections
- Easy adaptation to any switchgear and trip scheme

PROTECTION

- Light L>
- Light and Pressure L>/P>
- Circuit Breaker Failure Protection 50BF
- Trip time using mechanical trip relays: 7 ms*
- Reset time (arc light stage): 2 ms
- Protection operational after power up: 88 ms
- *total trip time using arc light (L>) or phase/ground overcurrent (I>) from AQ-110 and arc light (L>)

I/O

Applicable sensors: Max. 3 sensor loops

- AQ-06 plastic fiber sensor (5-50m length)
- AQ-07 glass fiber sensor (5-60m length)

Trip Relays T1, T2, T3, T4

- Number: 3 NO + 1 NC or 4 NO
- Rated voltage: 250 Vac/dc
- Continuous carry: 5 A
- Make and carry for 0.5s: 30 A

- Make and carry for 3s: 16 A
- Breaking capacity DC, when time constant L/R=40 ms: 40 W; 0.36 A at 110 Vdc
- Contact material: AgNi 90/10

Binary Output BO1

- Rated voltage: +24 Vdc
- Rated current: 20 mA (max)
- Number of outputs: 1

Binary Inputs B11, B12

- Threshold Voltage: 24 Vdc
- Rated Voltage: 250 V
- Rated current: 3 mA
- Number of inputs: 2

Power supply

- Us: 80...265 Vac/dc (option 18...72 Vdc)
- Maximum interruption: 100 ms
- Maximum power consumption: 5 W
- Standby current: 90 mA

HMI

- Indication LED's: 12
- Multifunction push button
- Autoconfiguration
- Indication reset
- System check

SELF SUPERVISION

- Sensors and wiring
- Binary I/O
- Trip coil
- Power supply
- Internal voltages
- Settings

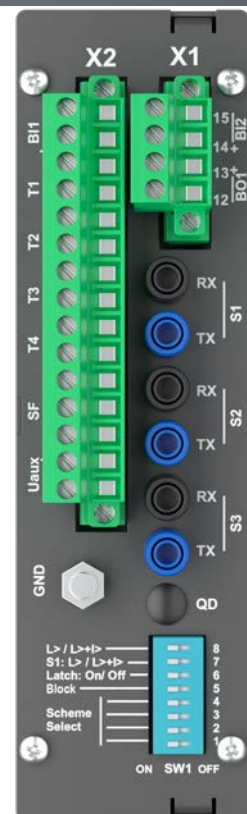

AQ-102LV rear view

AQ-1000 ARC Quenching device

AQ-1000 arc quenching device extinguishes arcing faults in systems with rated voltage of below 690 V. The AQ 1000 arc quenching system is developed to limit the total arcing time to 5 ms and to minimize or even eliminate the arcing fault thermal and pressure damaging effects. In most applications this will result in a calorie/cm² energy release of less than 1. The AQ-1000 is fully reusable allowing for full system testing at site.

The AQ-1000 is utilized in conjunction with the AQ 100 arc protection system. In case of an arc fault the AQ-100 detects the fault, initiates the AQ 1000 arc quenching system and simultaneously trips the fault feeding circuit breaker(s). The AQ-1000 creates a three-phase low-impedance parallel path for fault current to flow thus extinguishing the arc fault. The total arcing time is less than 5 ms.



ORDER CODE

AQ-1000 - X	
Standard features	
Arc quenching device (690 V)	
Auxiliary Power Supply	
A 80...265 Vac/dc	
B 18...72 Vdc	
Accessories	Order Code
Connection fiber, length 3 meters	AX 0 0 1 - 3
Connection fiber, length 5 meters	AX 0 0 1 - 5
Connection fiber, length 10 meters	AX 0 0 1 - 10

- Mitigates risk of injury to personnel during operations and maintenance
- Minimizes damage to equipment
- Applicable for new or retrofit installation

TECHNICAL DATA

- Rated voltage: up to 690 V
- Short-circuit withstand (IEC60947-9-1/UL2748): 100 kA for 200 ms, 50 kA for 1 second
- BIL: 12 kV
- Electric life: 2 operations at 100 kA, 200 ms each
- Mechanical life: 100 operations
- Total system operating time: 5 ms

Re-usable arc quenching device for less than 5 ms total arcing time.

POINT SENSORS

Arcteq offers a choice of different types of arc sensors to be utilized in different units and different switchgear types according to specific application requirements. Available sensor types are arc light point sensors and combined pressure and light sensors. There is a separate sensor for demanding GIS installations.

- **Selectable light intensity threshold**
- **Unique combination of arc light and pressure**
- **Easy installation and full supervision on connection**

AQ-01 - ARC LIGHT POINT SENSOR

- 8000 – 50 000 Lux light intensity threshold
- Pick-up time <1 ms
- 180 degrees detection radius
- IP64 mechanical protection
- maximum three sensors series connected
- standard shielded twisted pair 0.75 mm² wiring arrangement
- maximum wire length 200 meters
- operating temperature -20...+85 °C



AQ-02 - ARC LIGHT AND PRESSURE POINT SENSOR

- 8000 – 50 000 Lux light intensity threshold
- 0.2 bar above ambient pressure threshold
- Pick-up time <1 ms
- 180 degrees detection radius
- IP64 mechanical protection
- maximum three sensors series connected
- standard shielded twisted pair 0.75 mm² wiring arrangement
- maximum wire length 200 meters
- operating temperature -20...+85 °C



AQ-01 GIS - ARC LIGHT POINT SENSOR

- Especially designed for GIS installations
- 8000 – 50 000 Lux light intensity threshold
- 180 degrees detection radius
- IP64 mechanical protection
- maximum three sensors series connected
- standard shielded twisted pair 0.75 mm² wiring arrangement
- maximum wire length 200 meters
- operating temperature -20...+85 °C



AST-02 SENSOR TESTING DEVICE

- Arc Sensor Tester
- Aux: 80...265 Vac/dc
- Pressure input: 0,03...0,15 MPa (0,3...1,5 bar / 5...20 psi)
- Light intensity: 8 kLux / 25 kLux / 50 kLux
- Activation time setting: 50 ms / 120 ms / 170 ms
- Remote and local control



FIBER OPTIC SENSORS

The fiber sensors ensure full light supervision of each compartment in the switchgear. The fiber can be supplied either in plastic or multithread glass fiber. The fiber optic sensors have 8000 Lux sensitivity thresholds.

- Detection radius 360°
- Bending radius 1 cm for glass fiber sensor
- Up to 60 length with one fiber

AQ-06 – ARC LIGHT FIBER SENSOR (PLASTIC)

- plastic fiber
- 8000 Lux light intensity threshold
- 360 degrees detection radius
- 5 cm bending radius
- maximum fiber length 50 meters
- operating temperature -40...+85 °C



AQ-07 – ARC LIGHT FIBER SENSOR (GLASS)

- covered glass fiber
- 8000 Lux light intensity threshold
- 360 degrees detection radius
- 1 cm bending radius
- maximum fiber length 60 meters
- operating temperature -40...+85 °C

AQ-08 – ARC LIGHT FIBER SENSOR (GLASS, HIGH TEMPERATURE)

- covered glass fiber
- 8000 Lux light intensity threshold
- 360 degrees detection radius
- 1 cm bending radius
- maximum fiber length 40 meters
- operating temperature -40...+125 °C



SELECTION TABLE

FEATURES	AQ-110F	AQ-110P	AQ-102
Wide range power supply (18-72 Vdc or 80-265 Vac/dc)	✓	✓	✓
Mounting	Panel / rack		Panel / rack
3 phase and ground current detection (1/5 A)	✓	✓	
3 phase current detection (1/5 A)			
Master trip functionality	X	X	X
Applicable standard configurations	20	20	20
Max number of point sensors			
Max number of fiber loop sensors	3		3
Connectivity to arc quenching system	✓	✓	
High speed outputs (2 ms trip time)	2		
Number of trip relays (7 ms trip time)	4*		4*
System failure relay	1		1
Binary outputs (24 Vdc)	1		1
Binary inputs (24/110/220 Vdc)	2		2
Binary inputs (24 Vdc)			
Push button	✓	✓	✓
Non-volatile memory	✓	✓	✓
Indication LEDs	20		12
Applicable sensors			
AQ-01 a,b,c **light sensor		✓	
AQ-02 light and pressure sensor		✓	
AQ-06 plastic fiber sensor (5-50m length)	✓		✓
AQ-07 glass fiber sensor (5-60m length)	✓		✓

*Optionally one normally closed electronic lock-out/trip relay available

** a = 8,000 Lux activation, b = 25,000 Lux activation, c = 50,000 Lux activation

2	AQ-101	AQ-101D	AQ-101S	AQ-110FLV	AQ-110PLV	AQ-102LV	AQ-101LV	AQ-101DLV
	✓	✓	✓	✓	✓	✓	✓	✓
ck	Panel / rack	Din rail	Panel / rack	Panel / rack	Panel / rack	Panel / rack	Panel / rack	Din rail
				✓	✓			
	X	X	X					
	20	20	20		7	7	7	7
	12	12	12		12		12	12
	1 (option)	1 (option)		3	1 (option)	3	1 (option)	1 (option)
				✓	✓			
				2	2			
	4*	4*	3*	4*	4*	4*	4*	4*
	1	1	1	1	1	1	1	1
	1	1	3	1	1	1	1	1
	2	2	6					
				2	2	2	2	2
	✓	✓	✓	✓	✓	✓	✓	✓
	✓	✓	✓	✓	✓	✓	✓	✓
	12	12	17	19	19	12	12	12
	✓	✓	✓		✓		✓	✓
	✓	✓	✓		✓		✓	✓
	(option)	(option)		✓	(option)	✓	(option)	(option)
	(option)	(option)		✓	(option)	✓	(option)	(option)

TECHNICAL DATA

PROTECTION STAGES

Trip time using HSO	2 ms*
Trip time using mechanical trip relays	7 ms*
Reset time (light stage)	1 ms
Reset time (overcurrent stages)	50 ms
Protection operational after power up	50 ms (AQ-110) 88 ms (AQ-101 and 102)

*total trip time using arc light (L-) or phase/ground overcurrent (I-) and arc light (L-)

PROTECTION

Trip time using mechanical trip relays	7 ms*
Reset time (arc light stage)	2 ms
Protection operational after power up	88 ms

*total trip time using arc light (L-) or phase/ground overcurrent (I-) from AQ-110 and arc light (L-)

AUXILIARY VOLTAGE

Us	80...265 Vac/dc (option 18...72 Vdc)
Maximum interruption	100 ms
Maximum power consumption	5 W
Standby current	90 mA

TRIP RELAYS T1, T2, T3, T4

Number	3 NO + 1 NC or 4 NO
Rated voltage	250 Vac/dc
Continuous carry	5 A
Make and carry for 0.5s	30 A
Make and carry for 3s	16 A
Breaking capacity DC, when time constant L/R=40 ms	40 W; 0.36 A at 110 Vdc
Contact material	AgNi 90/10

HIGH SPEED OUTPUTS HSO1, HSO2

Number	2
Rated voltage	250 Vdc
Continuous carry	2 A
Make and carry for 0.5s	15 A
Make and carry for 3s	6 A
Breaking capacity DC, when time constant L/R=40 ms	1 A / 110 W
Contact material	Semiconductor

BINARY OUTPUT BO1

Rated voltage	+24 Vdc
Rated current	20 mA (max)
Number of outputs	1

BINARY INPUTS BI1, BI2

Rated voltage	24 or 110 or 220 Vdc
Rated current	3 mA
Number of inputs	2

DISTURBANCE TESTS

EMC test	CE approved and tested according to EN60255-26
Emission	0.15 – 30 MHz 30 - 1000 MHz
- Conducted (EN55011 class A / CISPR22)	
- Emitted (EN55011 class A / CISPR11)	
Immunity	
- Static discharge (ESD) (According to EN60255-22-2 and EN61000-4-2, severity class 4)	Air discharge 15 kV Contact discharge 8 kV
- Fast transients (EFT) (According to EN61000-4-4, class III and EN60255-22-4, level 4)	Power supply input 4 kV, 5/50 ns other inputs and outputs 4 kV, 5/50 ns
- Surge (According to EN61000-4-5, level 4 and EN60255-22-5)	Between wires 2 kV / 1.2/50 µs Between wire and ground 4 kV / 1.2/50 µs
- RF electromagnetic field test (According to EN 61000-4-3, class III)	f=80.....1000 MHz 10 V/m
- Conducted RF field (According to EN 61000-4-6, class III)	f=150 kHz.....80 MHz 10 V

VOLTAGE TESTS

Insulation test voltage according to IEC 60255-5	2 kV, 50 Hz, 1 min
Impulse test voltage according to EN60255-5	5 kV, 1.2/50 us, 0.5 J

MECHANICAL TESTS

Vibration test	2 ... 13.2 Hz ±3.5 mm 13.2 ... 100 Hz, ±1.0 g
Shock/Bump test according to IEC 60255-21-2	20 g, 1000 bumps/dir.

CASING AND PACKAGE	
Protection degree (front)	IP 50
Protection degree (back)	IP 20
Dimensions (W x H x D mm)	45 x 164 x 157 mm
Weight	0.7 kg 1.0 kg (with package)

ENVIRONMENTAL CONDITIONS	
Specified ambient service temp. range	-35...+70°C
Transport and storage temp. range	-40...+70°C
Relative humidity	Up to 97%

Certificates



TYPICAL WIRING DIAGRAM

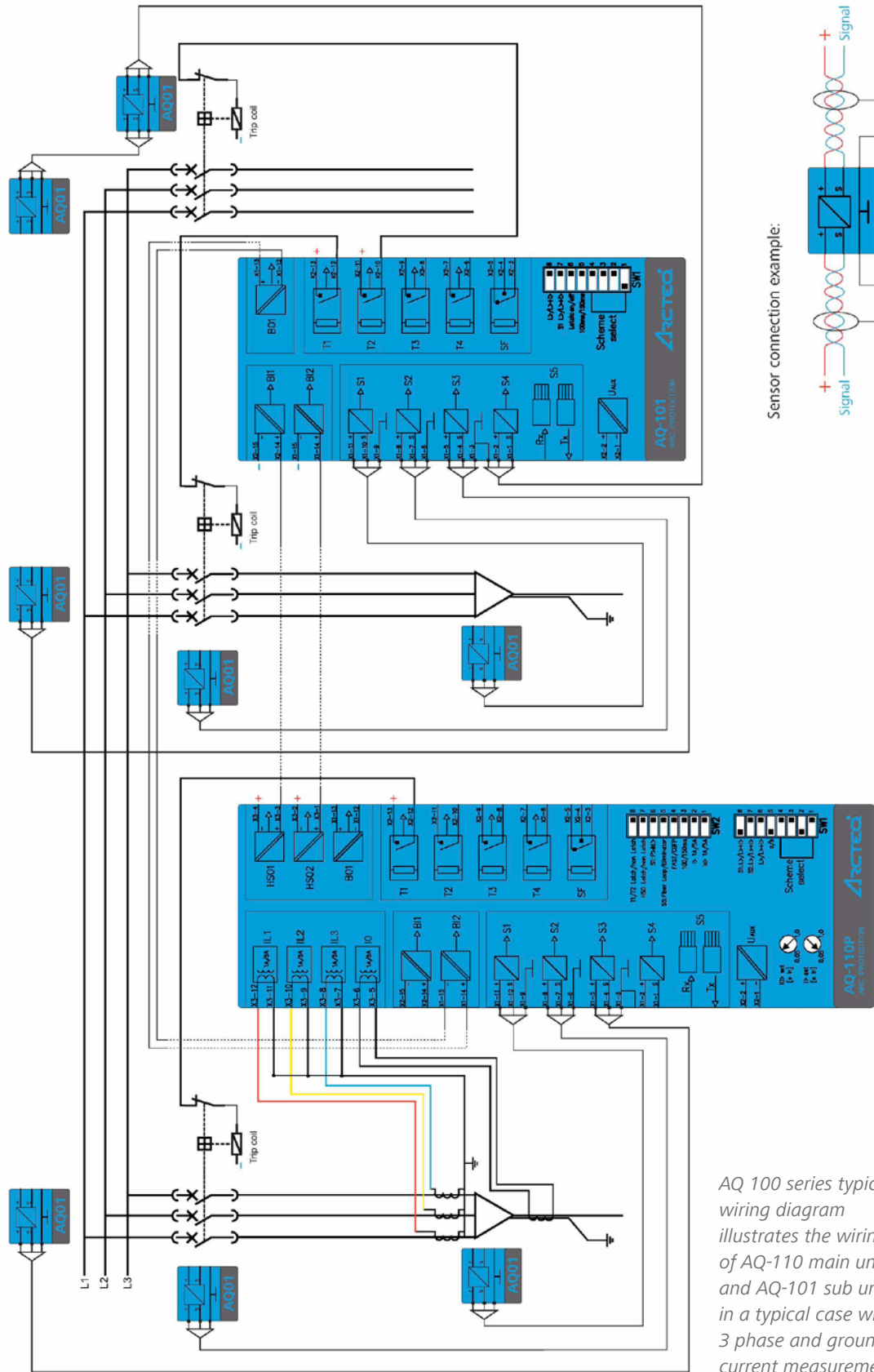

AQ 100 series typical wiring diagram illustrates the wiring of AQ-110 main unit and AQ-101 sub unit, in a typical case with 3 phase and ground current measurement.

AQ-110F/P INSTALLATION AND DIMENSIONS

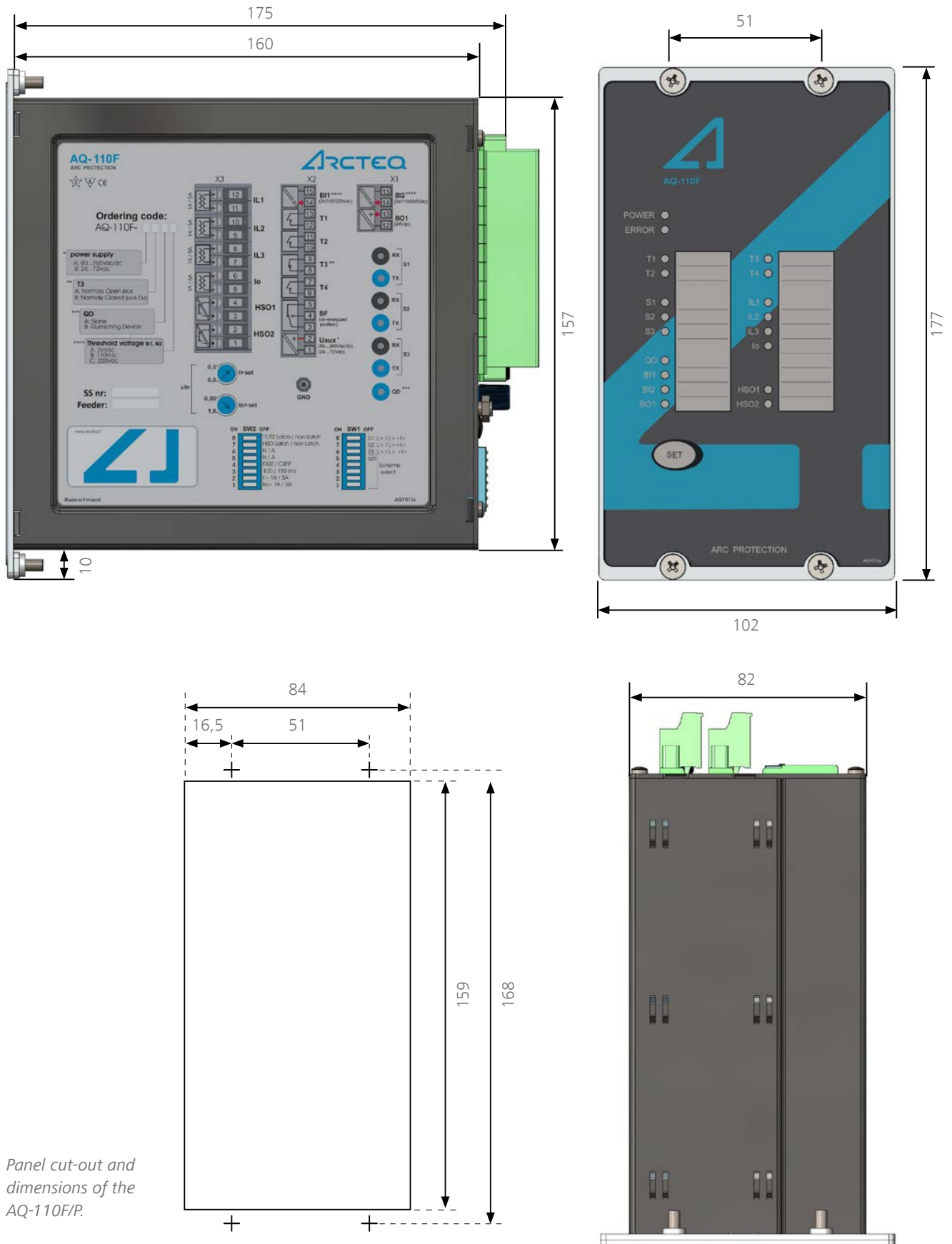

Panel cut-out and dimensions of the AQ-110F/P.

AQ-101 /S INSTALLATION AND DIMENSIONS

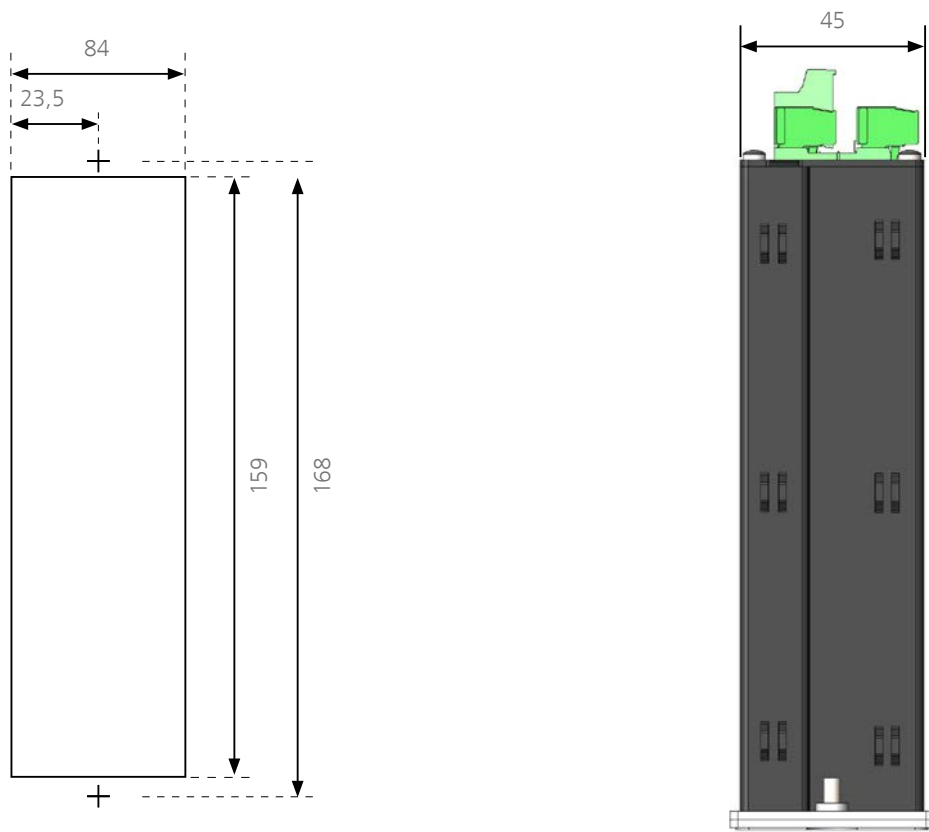
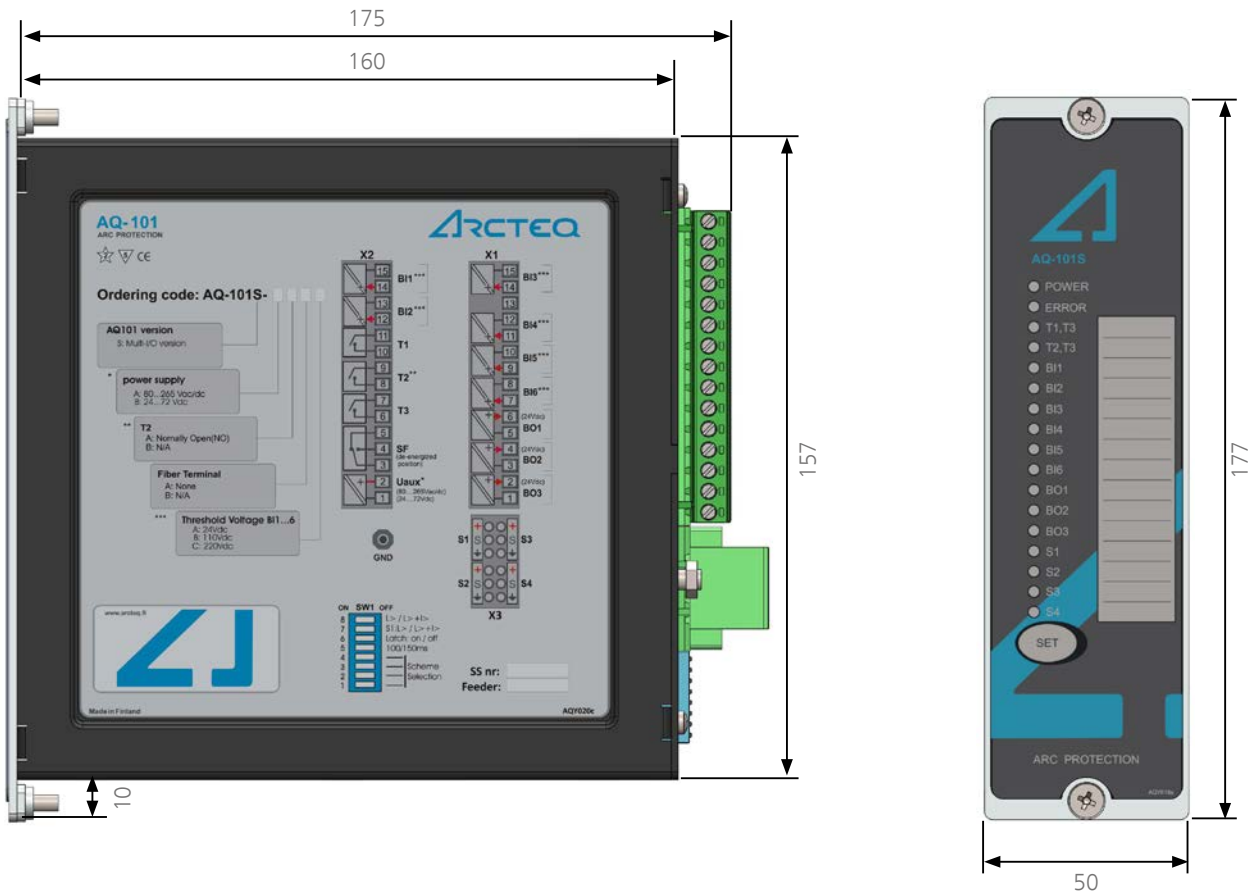

Panel cut-out and dimensions of the AQ-101 /S.

AQ-101D INSTALLATION AND DIMENSIONS

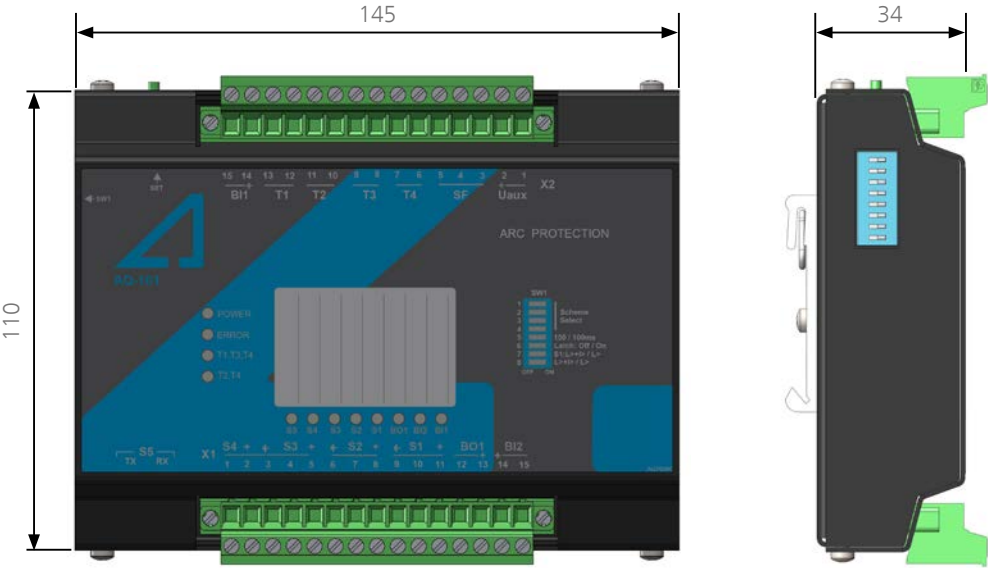

Dimensions of the AQ-101D.



HEADQUARTERS

Arcteq Relays Ltd
Wolffintie 36 F 12
65200 Vaasa, Finland
tel: +358 10 3221 370
fax: +358 10 3221 389

EMAIL INQUIRIES:

sales@arcteq.fi

EMAIL TECHNICAL SUPPORT:

support@arcteq.fi
Support line (EET 9:00 – 17:00)
+358 10 3221 388